



# **Dialogic<sup>®</sup> DSI Diameter Stack**

## **DMR Programmer's Manual**

**July 2017**

---

[www.dialogic.com](http://www.dialogic.com)

## Copyright and Legal Notice

Copyright © 2012-2017 Dialogic Corporation. All Rights Reserved. You may not reproduce this document in whole or in part without permission in writing from Dialogic Corporation at the address provided below.

All contents of this document are furnished for informational use only and are subject to change without notice and do not represent a commitment on the part of Dialogic Corporation and its affiliates or subsidiaries ("Dialogic"). Reasonable effort is made to ensure the accuracy of the information contained in the document. However, Dialogic does not warrant the accuracy of this information and cannot accept responsibility for errors, inaccuracies or omissions that may be contained in this document.

INFORMATION IN THIS DOCUMENT IS PROVIDED IN CONNECTION WITH DIALOGIC® PRODUCTS. NO LICENSE, EXPRESS OR IMPLIED, BY ESTOPPEL OR OTHERWISE, TO ANY INTELLECTUAL PROPERTY RIGHTS IS GRANTED BY THIS DOCUMENT. EXCEPT AS PROVIDED IN A SIGNED AGREEMENT BETWEEN YOU AND DIALOGIC, DIALOGIC ASSUMES NO LIABILITY WHATSOEVER, AND DIALOGIC DISCLAIMS ANY EXPRESS OR IMPLIED WARRANTY, RELATING TO SALE AND/OR USE OF DIALOGIC PRODUCTS INCLUDING LIABILITY OR WARRANTIES RELATING TO FITNESS FOR A PARTICULAR PURPOSE, MERCHANTABILITY, OR INFRINGEMENT OF ANY INTELLECTUAL PROPERTY RIGHT OF A THIRD PARTY.

Dialogic products are not intended for use in certain safety-affecting situations. Please see <http://www.dialogic.com/company/terms-of-use.aspx> for more details.

Due to differing national regulations and approval requirements, certain Dialogic products may be suitable for use only in specific countries, and thus may not function properly in other countries. You are responsible for ensuring that your use of such products occurs only in the countries where such use is suitable. For information on specific products, contact Dialogic Corporation at the address indicated below or on the web at [www.dialogic.com](http://www.dialogic.com).

It is possible that the use or implementation of any one of the concepts, applications, or ideas described in this document, in marketing collateral produced by or on web pages maintained by Dialogic may infringe one or more patents or other intellectual property rights owned by third parties. Dialogic does not provide any intellectual property licenses with the sale of Dialogic products other than a license to use such product in accordance with intellectual property owned or validly licensed by Dialogic and no such licenses are provided except pursuant to a signed agreement with Dialogic. More detailed information about such intellectual property is available from Dialogic's legal department at 3300 Boulevard de la Côte-Vertu, Suite 112, Montreal, Quebec, Canada H4R 1P8. **Dialogic encourages all users of its products to procure all necessary intellectual property licenses required to implement any concepts or applications and does not condone or encourage any intellectual property infringement and disclaims any responsibility related thereto. These intellectual property licenses may differ from country to country and it is the responsibility of those who develop the concepts or applications to be aware of and comply with different national license requirements.**

Dialogic, Dialogic Pro, Veraz, Brooktrout, Diva, BorderNet, PowerMedia, PowerVille, PowerNova, MSaaS, ControlSwitch, I-Gate, Cantata, TruFax, SwitchKit, Eiconcard, NMS Communications, SIPcontrol, Exnet, EXS, Vision, inCloud9, and NaturalAccess, among others as well as related logos, are either registered trademarks or trademarks of Dialogic Corporation and its affiliates or subsidiaries. Dialogic's trademarks may be used publicly only with permission from Dialogic. Such permission may only be granted by Dialogic's legal department at 3300 Boulevard de la Côte-Vertu, Suite 112, Montreal, Quebec, Canada H4R 1P8. Any authorized use of Dialogic's trademarks will be subject to full respect of the trademark guidelines published by Dialogic from time to time and any use of Dialogic's trademarks requires proper acknowledgement.

The names of actual companies and products mentioned herein are the trademarks of their respective owners.

This document discusses one or more open source products, systems and/or releases. Dialogic is not responsible for your decision to use open source in connection with Dialogic products (including without limitation those referred to herein), nor is Dialogic responsible for any present or future effects such usage might have, including without limitation effects on your products, your business, or your intellectual property rights

Publication Date: July 2017

Document Reference: U01DMR

## Revision History

Issue	Date	Description
5	21-Jul-17	Addition of Tcc timer functionality.
4	30-Sep-13	Addition of resource removal message definitions
3	22-Feb-13	Multiple updates including addition of new Notify Reason & Abort Reason parameter values.
2	04-Jan-13	Additional primitive types added to DMR Session Indications and Requests Additional statistics supported.
1	31-Oct-12	Initial Release for use during Dialogic® DSI Diameter Stack beta trial.

**Note:** The current version of this guide can be found at:  
<http://www.dialogic.com/support/helpweb/signaling>

# Contents

<b>Revision History</b> .....	<b>3</b>
<b>1 Introduction</b> .....	<b>6</b>
1.1 Applicability .....	6
1.2 Related Documentation .....	6
<b>2 General Description</b> .....	<b>7</b>
2.1 Feature Overview .....	7
2.2 Module interfaces .....	7
2.3 Functional API .....	8
2.4 Configuration .....	9
2.5 Message Tracing.....	9
2.6 Measurements.....	9
2.7 Event Reporting.....	9
2.8 User Action .....	9
2.9 Policy Based Routing .....	10
2.10 Supervision Timer Tcc .....	12
<b>3 Configuration Model</b> .....	<b>14</b>
3.1 Module Configuration .....	14
3.2 System Configuration.....	15
3.3 Configuration Sequence.....	15
<b>4 Message Reference</b> .....	<b>16</b>
4.1 Message Type Summary .....	16
4.2 User Interface Messages.....	17
4.2.1 Session Control Primitives - Parameter Area .....	18
4.2.2 Session Control Primitives - Primitive Type .....	19
4.2.3 Session Control Primitives - Parameters .....	20
4.2.4 DMR_MSG_SESSION_REQ – Diameter Session Request .....	22
4.2.5 DMR_MSG_SESSION_IND – Diameter Session Indication .....	24
4.3 Configuration Messages.....	26
4.3.1 Configuration Parameter Format.....	27
4.3.2 Configuration Parameter Definitions.....	28
4.3.3 DMR_MSG_CONFIG - Diameter Configuration Message .....	29
4.3.4 DMR_MSG_NC_CFG – Diameter NC Configuration.....	31
4.3.5 DMR_MSG_APP_CFG – Diameter Application Configuration .....	33
4.3.6 DMR_MSG_PEER_CFG – Diameter Peer Configuration .....	35
4.3.7 DMR_MSG_ROUTE_CFG – Diameter Route Configuration.....	37
4.3.8 DMR_MSG_ROUTE_LIST_CFG – Diameter Route List Configuration .....	39
4.3.9 DMR_MSG_APP_REM – Remove Diameter Application Configuration .....	41
4.3.10 DMR_MSG_PEER_REM – Remove Diameter Peer Configuration.....	42
4.3.11 DMR_MSG_ROUTE_REM – Remove a Diameter Route Configuration.....	43
4.3.12 DMR_MSG_ROUTE_LIST_REM – Remove a Diameter Route List Configuration.....	44
4.3.13 DMR_MSG_NC_REM – Remove Diameter Network Context Configuration.....	45
4.3.14 DMR_MSG_TIMER_CFG – Diameter Timer Configuration.....	46
4.4 Management Request Messages .....	47
4.4.1 DMR_MSG_PEER_ACTIVATE – Diameter Peer Activate Request .....	48
4.4.2 DMR_MSG_PEER_DEACTIVATE – Diameter Peer Deactivate Request.....	49
4.4.3 DMR_MSG_S_TRACE_MASK – Set Diameter Trace Masks .....	50
4.4.4 DMR_MSG_R_NC_STATS – Diameter NC Statistics .....	53
4.4.5 DMR_MSG_R_PEER_STATE – Read Peer State Request .....	55
4.4.6 DMR_MSG_R_PEER_STATS – Diameter Peer Statistics .....	56
4.4.7 DMR_MSG_R_APP_STATS – Diameter Application Statistics.....	58
4.4.8 DMR_MSG_R_ROUTE_STATS – Diameter Route Statistics.....	60
4.4.9 DMR_MSG_R_RL_STATS – Diameter Route List Statistics .....	61
4.5 Event Indication Messages.....	62
4.5.1 DMR_MSG_EVENT_IND – Diameter Event Indication.....	63
4.5.2 DMR_MSG_ERROR_IND – Diameter Error Indication .....	67
4.5.3 DMR_MSG_PEER_STATE_IND - Peer Connection State Indication .....	69

**5 External Message Definitions ..... 71**

**Figures**

Figure 1. Dialogic® DSI Diameter Stack – DMR Context Diagram ..... 8  
Figure 2: Route Table Structure..... 10  
Figure 3: Example route configuration ..... 11  
Figure 4: Route Selection Flow ..... 12

# 1 Introduction

The Dialogic® DSI Diameter Stack is a software implementation of the IETF Diameter Base Protocol which is intended to facilitate development of user applications that interface to LTE and IMS networks for the implementation of services in the areas of: Mobility, Online Charging and Offline Charging.

The Dialogic® DSI Diameter Stack includes a message based binary Diameter Module, a Functional API Library and utility components and header files for use when developing a User Application.

Dialogic's Diameter Module (DMR) implements the Diameter Base Protocol offering a message based API to the User Application to control Diameter sessions. DMR is a member of the family of Dialogic® DSI Components and offers similar message-based interfaces and management capabilities to those offered for other SS7 and SIGTRAN protocol layers. DMR uses the services provided by the SCTP layer of the Dialogic® DSI SIGTRAN Stack for the transfer of messages between Diameter Peers.

Dialogic's Diameter Functional API is an API layer for use by the User Application allowing easy development of Diameter applications without being encumbered with complex encoding and decoding rules.

DMR is an event driven task that uses standard structured message types for communication with other layers of the protocol stack. These messages are used to convey the protocol primitives between DMR and the User application and between DMR and SCTP.

This manual provides details of the interface to DMR. It is intended for use during Configuration, Operation and Maintenance of systems that use the DSI Diameter Stack. Application Developers should refer instead to the Diameter Functional API Manual.

## 1.1 Applicability

This manual is applicable to the following software:

Dialogic® DSI Development Package for Solaris – Release 5.7.5 or later

Dialogic® DSI Development Package for Linux – Release 6.8.11 or later

## 1.2 Related Documentation

Current software and documentation supporting Dialogic® DSI components is available at: <http://www.dialogic.com/support/helpweb/signaling>

The following User Documentation relates to the use of the Dialogic® DSI Diameter Stack:

- *Dialogic® DSI Diameter Stack - Diameter Functional API Manual*
- *Dialogic® DSI Components - Software Environment Programmer's Manual*
- *Dialogic® DSI SIGTRAN Stack - SCTP Programmer's Manual*

## 2 General Description

### 2.1 Feature Overview

Features of the Dialogic® DSI Diameter Stack include:

- Implementation of Diameter Peer State Machine
- Transaction buffering and failover functionality
- Implementation of Session State Machines
- Implementation of Realm Routing Table
- Operation as Client or Server
- Functional API offering full encode/decode of messages
- Customizable API supporting interface extension and modification
- User loadable Diameter definition dictionaries

### 2.2 Module interfaces

The following figure (Figure 1) shows a Context Diagram for the Dialogic® DSI Diameter Stack - Diameter Module (DMR) showing the external interfaces to the module. Each interface is message based and connects to one of the following entities:

- Diameter User  
Typically using the Dialogic® DSI Diameter Stack Functional API libraries which provide access to the user module to allow it to send and receive the Diameter primitive messages.
- Management  
The module is configured using messages. Messages are also used to send indications of relevant events to the configured management module so they can be handled or logged.
- Timer  
The module derives timing signals from the timer module supplied as part of the Dialogic® DSI Development Package.
- SCTP  
The Dialogic® DSI SIGTRAN Stack SCTPN modules provide a message based interface and access to an SCTP network for message transport. This is the interface over which the Diameter payload messages are sent or received encoded as SCTP messages.

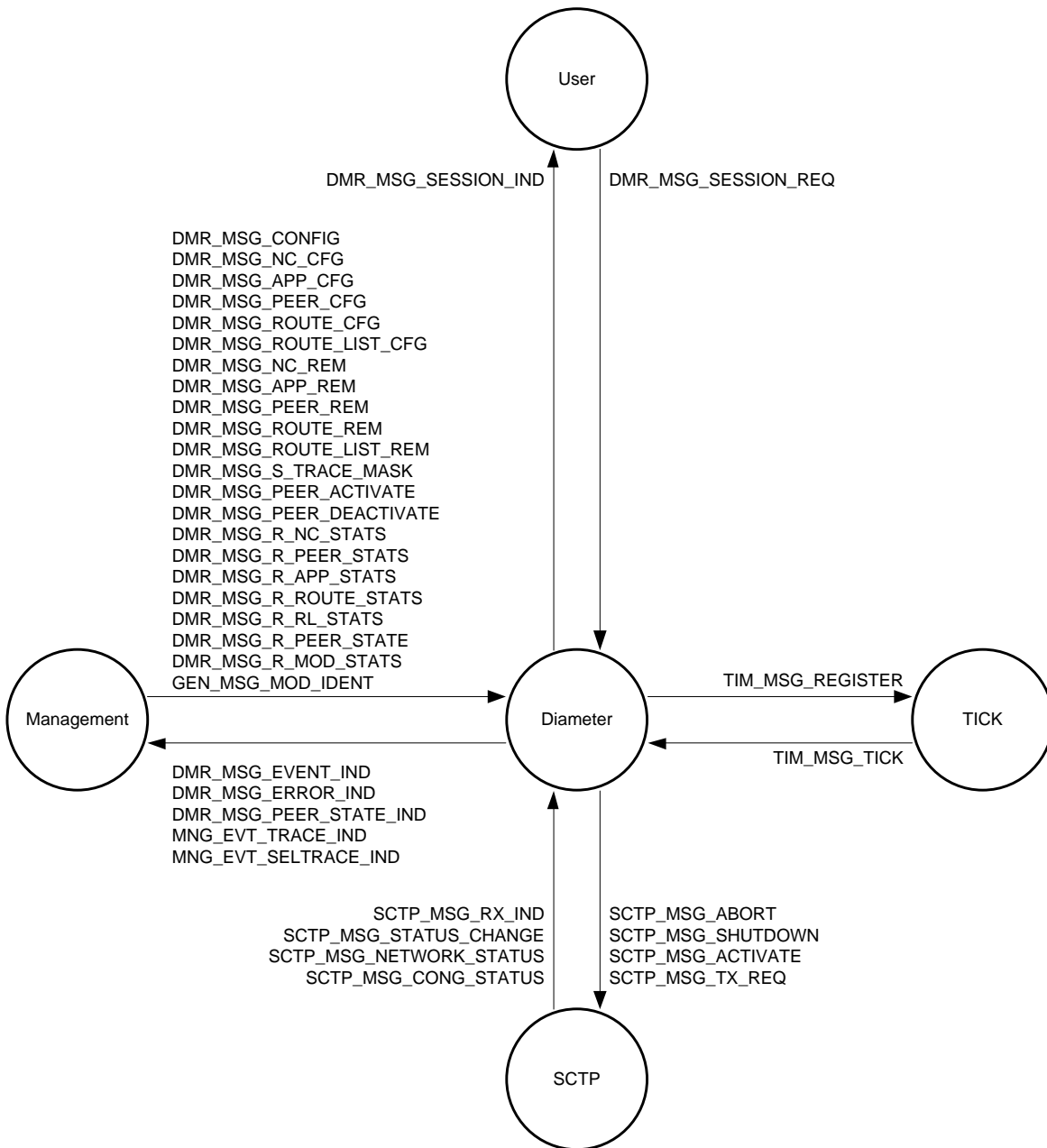

**Figure 1. Dialogic® DSI Diameter Stack – DMR Context Diagram**

## 2.3 Functional API

The Dialogic® DSI Diameter Stack is supplied with a supporting Diameter Functional API interface. This interface provides a mechanism to access all aspects of the message based interface exposed by the Diameter Module and is described further in the *Dialogic® DSI Diameter Stack - Diameter Functional API Manual*



## 2.4 Configuration

DMR is configured using messages which define the module set-up, including configuration and management settings to be used. The configuration model is discussed in further detail in section 3 and the messages used for configuration are defined in section 4.3. In most cases the user will not directly configure the module via these messages but will use the `s7_mgt` utility supplied in the DSI development package. It is also possible for the user application to generate the configuration messages directly.

## 2.5 Message Tracing

DMR provides tracing functionality to permit copies of messages sent or received by the module to be sent to a configurable trace module. This readily permits analysis and diagnosis of systems. The module can selectively trace different interfaces and message primitive types.

Further details of the message used to control the tracing can be found in section 4.4.3

## 2.6 Measurements

DMR supports a message based statistics gathering mechanism. A user application can send a message into the module for a configured Diameter Network context and the reply to the message will be populated with the relevant statistics such as session and transaction counts.

## 2.7 Event Reporting

DMR generates message based event and error indications to the configured management module for or logging protocol or operational events that have occurred.

Events generated include:

- Session Handling Event Indications
- Indications of errors detected during processing of messages
- Peer state changes

See section 4.5 Event Indication Messages for further details.

## 2.8 User Action

The Diameter protocol requires careful interpretation of answer messages in conjunction with runtime and configuration parameters such as `DirectDebitFailureHandling` or `CreditControlFailureHandling` to determine the correct action required by the Diameter Client. To aid compliance, interoperability and to ease application development the DMR module has been implemented to perform this interpretation for the client where appropriate. The client may then determine the required action by looking at the User Action parameter in the `DMR_SESSION_IND` message. This is defined in Section 4.2.3.

The User Action parameter is used in Credit Control applications (including the 3GPP Ro Online Charging interface) to indicate when service should be Granted or Denied, when messages should be Stored or Deleted and when a service error indication has occurred. It is used in Base Accounting applications (including the 3GPP Rf Offline Charging interface) to indicate when messages should be Stored or Deleted.

## 2.9 Policy Based Routing

DMR routing procedures use a routing table which is configured at system start time and used at run time. Route configuration and selection is made based on Diameter-Host or Diameter-Realm and Application-Id as per the Diameter specifications.

The Diameter module extends this functionality to offer greater routing control to the User application by allowing messages for a particular destination to be routed differently under the run time control of the user. For instance, the user application may wish to route all messages for a particular set of subscribers, or a particular command code via a different relay node for special processing. Or while testing a new feature certain messages may require routing via a test system.

This is achieved by the use of the optional 'policy\_id' parameter when both configuring a route and sending DMR\_SESSION\_REQ messages. DMR maintains routing tables which contain the configured routing rules. All entries within a routing table must be distinct such that it is deterministic which route will be selected for a given Destination-Host, Destination-Realm and Application-Id. The policy\_id allows the creation of multiple routing tables for the same Diameter Node. If a route configuration message has the policy\_id parameter included, then the route will be considered part of that specific routing table. When a message is received by DSI Diameter for routing, if the policy\_id is present then route selection will first search the corresponding route table.

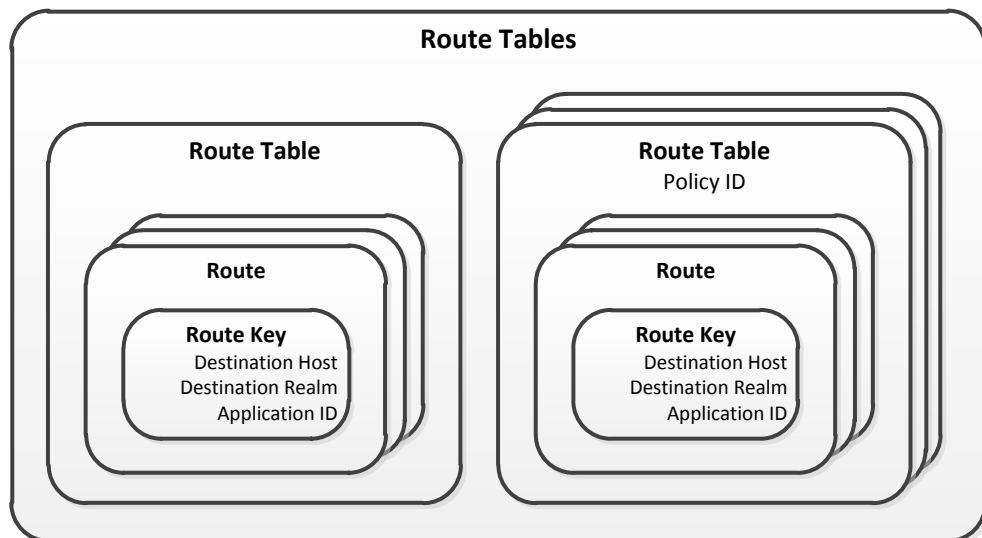

**Figure 2: Route Table Structure**

For example, if an application needs to route messages with Destination Realm 'Jupiter.com' via 'Peer Alpha' but wishes to route messages for certain subscribers via 'Peer Beta' in preference then this may be configured as follows:

- 1) The user configures Peer 0 (Peer Alpha)
- 2) The user configures Peer 1 (Peer Beta)
- 3) The user configures Route 0 with Destination Realm = 'Jupiter.com'. This route has no policy\_id.

- 4) The user configures Route List 0 mapping Route 0 with Peer A
- 5) The user configures Route 1 with Destination Realm = 'Jupiter.com' and Policy\_id = 1.
- 6) The user configures Route List 1 mapping Route 1 with Peer B (this will take the role of primary)
- 7) The user configures Route List 2 mapping Route 1 with Peer A (this will take the role of secondary)

This results in the configuration shown below.

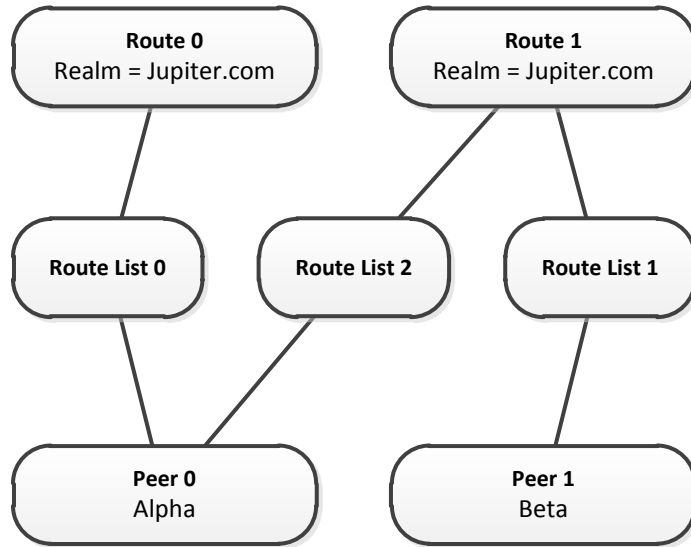

**Figure 3: Example route configuration**

At run time, the user application will determine which messages require special routing and will include the `policy_id` parameter set to the value 1. If the Destination-Realm equals 'Jupiter.com', then DMR will match and select Route 1 and, presuming it is available, Peer Beta.

The general flow through route selection logic is shown below.

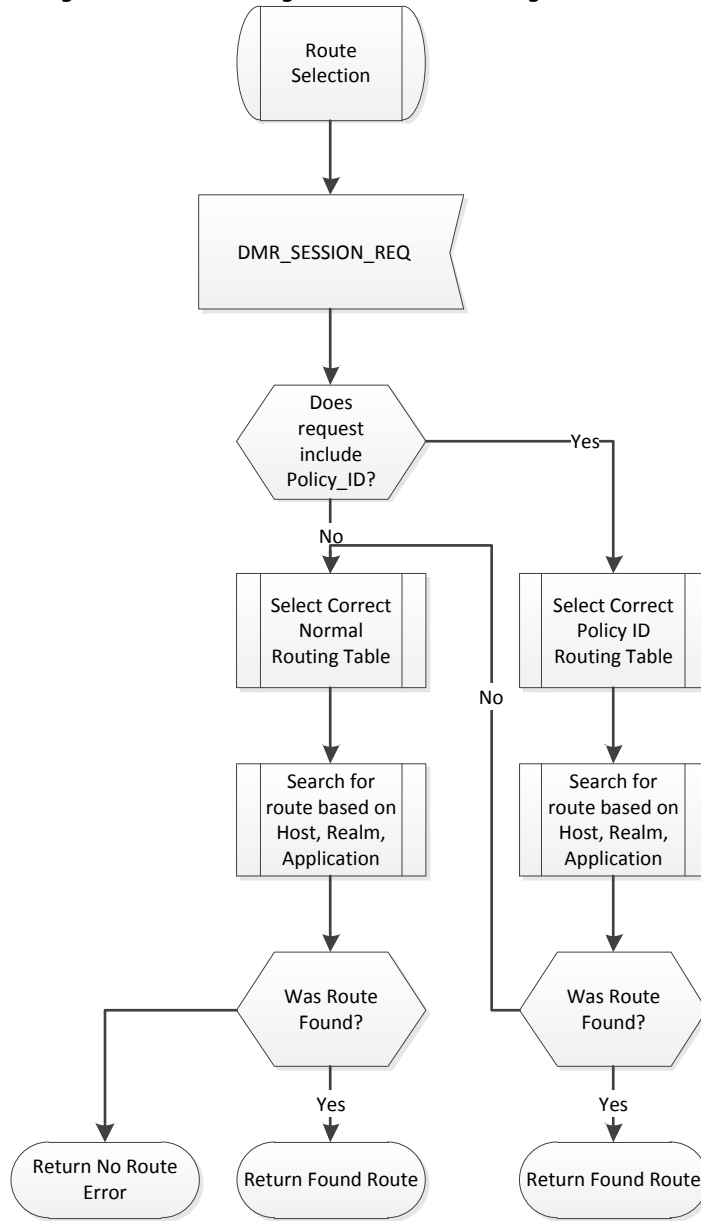

**Figure 4: Route Selection Flow**

Note: Route Configuration and Selection operates independently for different Network Contexts.

## 2.10 Supervision Timer Tcc

For Credit Control / Ro sessions DMR supports the RFC4006 TCC Supervision timer. When a Server sends an answer to a Client it starts Tcc. When it answers subsequent requests it restarts Tcc. When the session ends it stops Tcc. If Tcc expires DMR sends a Notify indication to the User indicating Tcc has expired (Notify reason 10). It also restarts Tcc. On receipt of the Notify Primitive the User Should Abort the Session by sending an Diameter Session Request with primitive type set to Abort to DMR. This will be confirmed with a Close Indication.

The Tcc timer duration is set to twice the value of the Validity-Time AVP from the Answer message currently being processed. DMR will first look for the Validity-Time AVP in the root of the Diameter Message and secondly in each Multiple-Services-Credit-Control AVP present; it will use the first instance of Validity-Time AVP it finds.

If no Validity-Time AVP is found then it will use a locally configured value (see section 4.3.14). The Timer Configuration message supports the configuration of TCC using parameter 'DMRCN\_TCC' which takes a timer duration measured in milliseconds

## 3 Configuration Model

### 3.1 Module Configuration

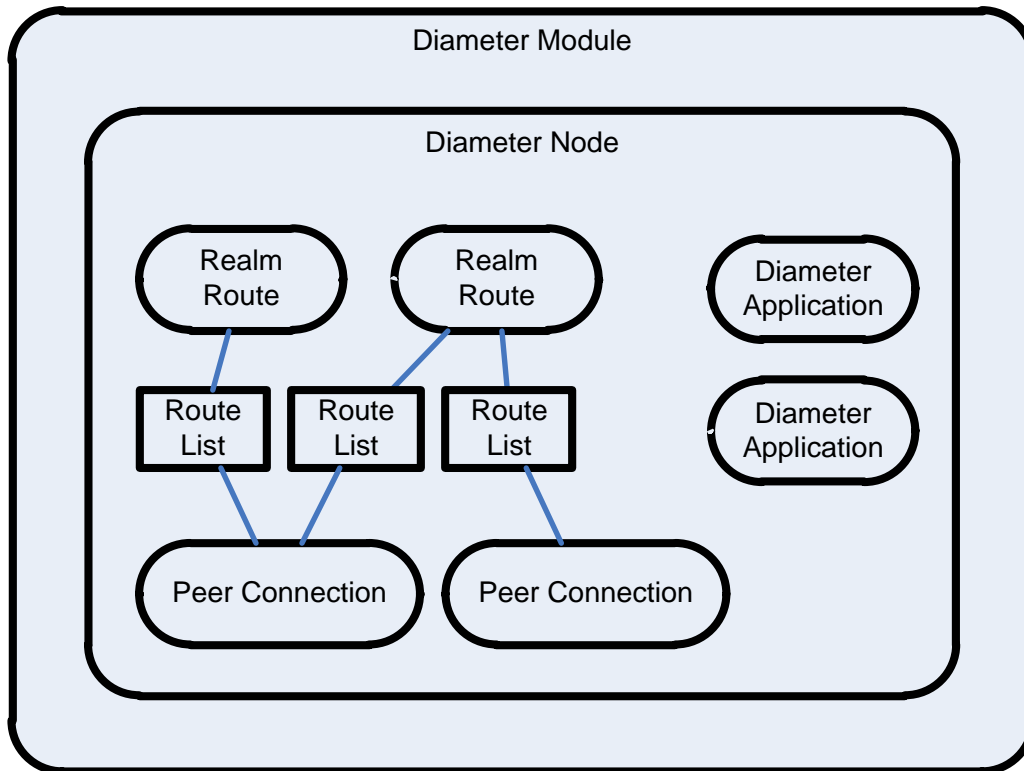

The module configuration consists of the following principal elements:

**Diameter Module:** The DSI Diameter Module (DMR) receives configuration to control run time resource allocation and configure communication with supporting modules.

**Diameter Node:** The module may simultaneously support several Diameter Nodes each of which is independently visible in the Diameter network(s). Each node has its own User-Name, Origin-Realm, Origin-Host and Peer Connections.

**Diameter Application:** Each Diameter Node optionally supports a number of Diameter Applications for which it can receive traffic. These will be advertised during Capabilities Exchange.

**Peer Connection:** A Peer connection encompasses the SCTP transport connection to a remote Peer and has a Peer State Machine instance supporting Capability exchange, Watchdog, Transaction buffering etc.

**Realm Route:** A Realm Route defines a set of Diameter Messages for routing purposes. The set is identified based on parameters including Destination-Realm, Destination-Host and Application ID. A realm route may have a number of Route Lists.

**Route List:** This identifies a Peer Connection to which messages belonging to a Realm Route may be forwarded.

## 3.2 System Configuration

The DSI Diameter Module can be configured as part of a complete signaling system using the `s7_mgt` utility supplied as part of the Dialogic DSI Development Package. This utility can generate the required configuration messages from an appropriate configuration file. See *Dialogic® DSI Components – Software Environment Programmer's Manual* for further details on the `s7_mgt` utility and the configuration syntax used.

## 3.3 Configuration Sequence

The following is the recommend configuration sequence for the module.

1. Configure the main module settings.

This will configure the module and define the module ids for the interfaces it will use to communicate with other parts of the system. It also allows module wide settings to be selected.

(See [DMR\\_MSG\\_CONFIG](#) - Diameter Configuration Message. The message is generated by `s7_mgt` if the command `SNSLI` defines one or more Diameter associations).

2. Configure one or more Network Contexts.

At least one of these is required and additional Network Contexts are required to connect to each distinct network. It defines settings that are specific to an individual network.

(See [DMR\\_MSG\\_NC\\_CFG](#) - Diameter NC Configuration. The equivalent `s7_mgt` command is `DMNCI` as defined in the Software Environment Programmer's Manual).

3. Configure each local application

Defines the local application to be supported for the purposes of capability negotiation. Also defines the mapping between the well-known AVP values for applications and a local application identifier.

(See [DMR\\_MSG\\_APP\\_CFG](#) - Diameter Application Configuration. The equivalent `s7_mgt` command is `DMAPI` as defined in the Software Environment Programmer's Manual).

4. Configure one or more Peer Connections

Defines a remote peer connection entity within a previously configured Network Context.

(See [DMR\\_MSG\\_PEER\\_CFG](#) - Diameter Peer Configuration. The equivalent `s7_mgt` command is `DMPRI` as defined in the Software Environment Programmer's Manual).

5. Configure one or more Routes

Defines the destination host and destination realm and links them to a Realm route.

(See [DMR\\_MSG\\_ROUTE\\_CFG](#) - Diameter Route Configuration. The equivalent `s7_mgt` command is `DMRTI` as defined in Software Environment Programmer's Manual).

6. Configure one or more Route Lists

Uses previously configured Realm Routes and Peer Connections.

(See [DMR\\_MSG\\_ROUTE\\_LIST\\_CFG](#) - Diameter Route List Configuration. The equivalent `s7_mgt` command is `DMRLI` as defined in the Software Environment Programmer's Manual).

## 4 Message Reference

### 4.1 Message Type Summary

The following table lists, by message type, the messages described in this manual.

Message Type	Mnemonic	Description
0x0465	<a href="#">DMR_MSG_EVENT_IND</a>	Diameter Event Indication
0x0466	<a href="#">DMR_MSG_ERROR_IND</a>	Diameter Error Indication
0x0468	<a href="#">DMR_MSG_PEER_STATE_IND</a>	Peer Connection State Indication
0x6467	<a href="#">DMR_MSG_S_TRACE_MASK</a>	Set Diameter Trace Masks
0x6470	<a href="#">DMR_MSG_R_PEER_STATE</a>	Read Peer State Request
0x646e	<a href="#">DMR_MSG_R_NC_STATS</a>	Diameter NC Statistics
0x6473	<a href="#">DMR_MSG_R_PEER_STATS</a>	Diameter Peer Statistics
0x6474	<a href="#">DMR_MSG_R_APP_STATS</a>	Diameter Application Statistics
0x6475	<a href="#">DMR_MSG_R_ROUTE_STATS</a>	Diameter Route Statistics
0x6476	<a href="#">DMR_MSG_R_RL_STATS</a>	Diameter Route List Statistics
0x7460	<a href="#">DMR_MSG_CONFIG</a>	Diameter Configuration Message
0x7461	<a href="#">DMR_MSG_NC_CFG</a>	Diameter NC Configuration
0x7462	<a href="#">DMR_MSG_APP_CFG</a>	Application Configuration
0x7463	<a href="#">DMR_MSG_PEER_CFG</a>	Diameter Peer Configuration
0x7464	<a href="#">DMR_MSG_ROUTE_CFG</a>	Diameter Route Configuration
0x746f	<a href="#">DMR_MSG_ROUTE_LIST_CFG</a>	Diameter Route List Configuration
0x7469	<a href="#">DMR_MSG_PEER_ACTIVATE</a>	Diameter Peer Activate Request
0x746a	<a href="#">DMR_MSG_PEER_DEACTIVATE</a>	Diameter Peer Deactivate Request
0x846d	<a href="#">DMR_MSG_SESSION_IND</a>	Diameter Session Indication
0xc46c	<a href="#">DMR_MSG_SESSION_REQ</a>	Diameter Session Request
0x7477	<a href="#">DMR_MSG_APP_REM</a>	Diameter Application Removal
0x7478	<a href="#">DMR_MSG_PEER_REM</a>	Diameter Peer Removal
0x7479	<a href="#">DMR_MSG_ROUTE_REM</a>	Diameter Route Removal
0x747a	<a href="#">DMR_MSG_ROUTE_LIST_REM</a>	Diameter Route List Removal
0x747b	<a href="#">DMR_MSG_NC_REM</a>	Diameter Network Context Removal
0x747c	<a href="#">DMR_MSG_TIMER_CFG</a>	Diameter Timer Configuration



## 4.2 User Interface Messages

Payload messages between DMR and the User Application are all exchanges in one of two message types – a Session Request which is generated by the Application and sent to DMR and a Session Indication which is sent from DMR to the Application.

Typically the user does not deal directly with these messages at the raw message level but makes use of the Diameter Functional API to create a correctly formatted message or recover the parameters from a message. Details of the Functional API for the Dialogic® DSI Diameter Stack is given in the *Diameter Functional API User Manual*.

This section describes the raw message format used on the interface between DMR and the User Application as follows:

- DMR\_MSG\_SESSION\_REQ – Diameter Session Request
- DMR\_MSG\_SESSION\_IND – Diameter Session Indication

### 4.2.1 Session Control Primitives - Parameter Area

The parameter area of the DMR\_MSG\_SESSION\_REQ and DMR\_MSG\_SESSION\_IND messages both use a Name-Length-Data structure within the parameter area to allow for variable size parameters and extensibility.

The Name-Length-Data method is used by several other Dialogic® DSI Stack Layers but the scheme used for DMR is different in that it always uses two bytes for the Parameter Name, two bytes for the Parameter Length and two bytes for the terminator zero.

The parameter area for each message is constructed as a single byte Primitive Name followed by a list of parameters (each in Name-Length-Data format), followed by a two byte terminator Name (set to zero) indicating that there are no further parameters.

The following diagrams illustrate the parameter area coding:

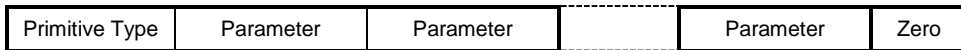

Each parameter is formatted as follows:

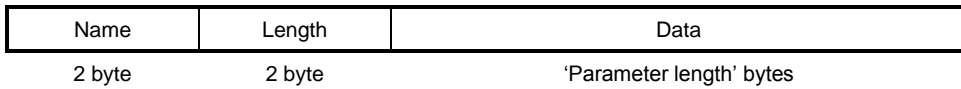

## 4.2.2 Session Control Primitives - Primitive Type

The coding of the Primitive Type octet uses in the Session Control Primitives is shown in the following table:

Primitive	Mnemonic	Value
DMR-OPEN	DMRSR_OPEN	1
DMR-CONTINUE	DMRSR_CONTINUE	2
DMR-CLOSE	DMRSR_CLOSE	3
DMR-P-ABORT	DMRSR_P_ABORT	4
DMR-NOTIFY	DMRSR_NOTIFY	5
DMR-ABORT	DMRSR_ABORT	6

A typical User Initiated session will begin with Session Request containing an Open Primitive, which includes the Diameter Command. In the simplest case this will be ended by the reception of a Session Indication containing a Close Primitive which includes Answer to the Diameter Command.

If the Diameter module detects a failure case not initiated by the Peer then a Session Indication containing P-Abort is generated.

### 4.2.3 Session Control Primitives - Parameters

The following parameter names are defined for use in session primitive messages:

Parameter	Mnemonic	Value (dec)
Network context	DMRPN_nc	1
Diameter message	DMRPN_dmtr_msg	2
Provider reason	DMRPN_prov_rsn	3
Routing policy key	DMRPN_routing_policy_key	4
Notify reason	DMRPN_notify_rsn	5
User Action	DMRPN_user_action	6
Storage message	DMRPN_storage_msg	7
Options	DMRPN_options	8

The coding for each parameter type is given in the following tables:

Parameter name	DMRPN_nc
Parameter length	Fixed, set to 2
Parameter data	Network Context Identifier. Defaults to zero if not supplied.

Parameter name	DMRPN_dmtr_msg
Parameter length	Variable. There is no specific max size of this parameter but the complete message containing this parameter must fit within the 4200 octet message structure.
Parameter data	A well-formed Diameter Message encoded compliant to RFC3588 starting with the Diameter Command Header and including all AVPs.

Parameter name	DMRPN_prov_rsn
Parameter length	Fixed, set to 2
Parameter data	Provider abort reason. Set to one of the following values. DMRPA_REQUEST_TIME_OUT = 1, DMRPA_GUARD_TIMER_TIMEOUT = 2, DMRPA_UNKNOWN_SSN = 3, DMRPA_FORMAT_ERR = 4, DMRPA_INVALID_REQ = 5, DMRPA_INVALID_COMMAND = 6, DMRPA_ROUTE_UNKNOWN = 7, DMRPA_ROUTE_UNAVAILABLE = 8, DMRPA_RESOURCE_UNAVAILABLE = 9, DMRPA_FAILURE_TO_SEND = 10
Parameter name	DMRPN_routing_policy_key
Parameter length	Fixed, set to 2
Parameter data	The policy identifier to be used to route the Diameter message. See section 2.9 Policy Based Routing.

Parameter name	DMRPN_notify_rsn
Parameter length	Fixed, set to 2
Parameter data	Reason for notice generation. DMRNR_FORMAT_ERR = 1, DMRNR_BAD_NC = 2, DMRNR_INVALID_REQ = 3, DMRNR_MISSING_PARAM = 4, DMRNR_COMMAND_PRS_ERR = 5, DMRNR_MISSING_AVP = 6, DMRNR_PENDING_RSP = 7, DMRNR_REQUEST_TIME_OUT = 8, DMRNR_FAILURE_TO_SEND = 9 DMRNR_TCC_TIMER_TIMEOUT = 10

Parameter name	DMRPN_user_action
Parameter length	Fixed, set to 4
Parameter data	User Action bit field. DMRUA_FLAGS_GRANT = 0x00000001 DMRUA_FLAGS_DENY = 0x00000002 DMRUA_FLAGS_STORE = 0x00000004 DMRUA_FLAGS_SVC_ERROR = 0x00000008 DMRUA_FLAGS_UNKNOWN = 0x00000010 DMRUA_FLAGS_DELETE = 0x00000020

Parameter name	DMRPN_storage_msg
Parameter length	Variable. There is no specific max size of this parameter but the complete message containing this parameter must fit within the 4200 octet message structure.
Parameter data	For Session Requests this parameter is used in place of the DMRPN_dmtr_msg parameter to indicate a message that had previously been stored and should now be resent, For Session Indications this parameter may be present to indicate a message that should be stored by the user application for later resending.  This parameter takes the same format as the DMRPN_dmtr_msg parameter and therefore is also a well-formed Diameter Message encoded compliant to RFC3588 starting with the Diameter Command Header and including all AVPs.

Parameter name	DMRSR_options
Parameter length	Fixed, set to 4
Parameter data	Session Request options bit map DMRSR_OPTS_KEEP_O_HOST = 0x00000001 DMRSR_OPTS_KEEP_O_REALM = 0x00000002

## 4.2.4 DMR\_MSG\_SESSION\_REQ – Diameter Session Request

### Synopsis

Message sent to the DMR module containing a Session Request Primitive.

### Format

Message Header		
Field Name	Meaning	
type	DMR_MSG_SESSION_REQ (0xc46c)	
id	session ID	
src	user application module id	
dst	DMR_TASK_ID	
rsp_req	0	
hclass	0	
status	0	
err_info	0	
len	Number of bytes of user data	
Parameter Area		
Offset	Size	Name
0	1	Session primitive type octet.
1	Len - 3	Parameters in Name-Length-Data format.
Len-2	2	Set to zero to indicate end of message.

### Description

This message is used by the User module to send session primitives to DMR.

All session primitives contain a Session ID, which is encoded in the message header. The Session ID is established by the module that generates the Open Primitive and used in all subsequent Session Primitives.

For an outgoing Session, the Diameter User is responsible for generating a Session ID. For an incoming Session DMR assigns the Session ID.

The following request primitive types are supported:

- **Open**  
Used to open a session. The request will also typically include a Diameter Command Request specified in the Diameter Message parameter (DMRPN\_dmtr\_msg). If the command was previously stored and now needs to be resent, then the command should be specified in the Storage Message parameter (DMRPN\_storage\_msg).
- **Continue**  
Used to request a session is maintained and also send either a Diameter Command Request or Answer.
- **Close**  
Used to request a session is closed. Typically also includes a Diameter Command Answer.

- **Abort**  
Used to request a session is aborted and session resources are freed.

**Parameter area contents:**

The following table lists the parameters associates with each session request primitive and shows whether the parameter is Mandatory (M), in which case the message will be discarded is the parameter is omitted, or Optional (O), in which case the parameter is not considered essential.

Parameter	Primitive				
	Open (1) (Diameter Message)	Open (1) (Storage Message)	Continue (2)	Close (3)	Abort
Network Context	O	O	-	-	-
Diameter Message	M	-	M	O	-
Routing Policy Key	O	O	-	-	-
Storage Message	-	M	O	-	-

## 4.2.5 DMR\_MSG\_SESSION\_IND – Diameter Session Indication

### Synopsis

Message sent issued by DMR to the DMR-User containing a session indication primitive.

### Format

Message Header		
Field Name	Meaning	
type	DMR_MSG_SESSION_IND (0x846d)	
id	session id	
src	DMR_TASK_ID	
dst	User application module id	
rsp_req	0	
hclass	0	
status	0	
err_info	0	
len	Number of bytes of user data	
Parameter Area		
Offset	Size	Name
0	1	Session primitive type octet.
1	Len -3	Parameters in Name-Length-Data format.
Len -2	2	Set to zero indicating end of message.

### Description

This message is used by the DMR to send session primitives to the DMR-User.

All session primitives contain the Session ID of the session to which they belong. It is encoded in the message header.

The following indication primitive types are supported:

- Open  
Used to indicate a session has been opened. Typically the indication also includes a Diameter Command Request.
- Continue  
Used to indicate a session is still open and also includes either a Diameter Command Request or Answer.
- Close  
Used to request a session is closed. Typically also includes a Diameter Command Answer.
- P\_Abort  
Used to indicate a session has been aborted for reason given in the Provider Reason parameter.
- Notify



Used to notify the application of an issue with a previous Session Request indicated by the Notify Reason parameter.

### Parameters

The following table lists the parameters associates with each session indication primitive and shows whether the parameter is Mandatory (M), in which case the message will be discarded is the parameter is omitted, or Optional (O), in which case the parameter is not considered essential.

Parameter	Primitive				
	Open (1)	Continue (2)	Close (3)	P Abort (4)	Notify (5)
Network Context	M		-	-	-
Diameter Message	M	O	O	-	-
Provider Reason	O	-	O	M	-
Notify Reason	-	-	-	-	M
User Action	-	O	O	O	O
Storage Message	-	O	O	O	O

## 4.3 Configuration Messages

The Diameter Module (DMR) configuration is applied at system startup through the use of the following configuration messages. Typically these messages are generated at startup time by the configuration utility `s7_mgt` which takes the configuration from the `config.txt` file. The commands used in `config.txt` are documented in the *Software Environment Programmer's Manual*.

When `s7_mgt` is used for configuration, the message definitions in this section are not needed by the user.

The configuration must start with the `DMR_MSG_CONFIG` module configuration message and then one or more `DMR_MSG_NC_CFG` messages to configure the Diameter Node(s). Each node will then have one or more Diameter Applications registered (`DMR_MSG_APP_CFG`) in addition to Diameter peers and Realm Routes.

The following configuration messages are documented in this section:

- `DMR_MSG_CONFIG` - Diameter Configuration Message
- `DMR_MSG_NC_CFG` - Diameter NC Configuration
- `DMR_MSG_APP_CFG` - Diameter Application Configuration  
`DMR_MSG_PEER_CFG` - Diameter Peer Configuration
- `DMR_MSG_ROUTE_CFG` - Diameter Route Configuration
- `DMR_MSG_ROUTE_LIST_CFG` - Diameter Route List Configuration
- `DMR_MSG_APP_REM` - Diameter Application Removal
- `DMR_MSG_PEER_REM` - Diameter Peer Removal
- `DMR_MSG_ROUTE_REM` - Diameter Route Removal
- `DMR_MSG_ROUTE_LIST_REM` - Diameter Route List Removal
- `DMR_MSG_NC_REM` - Diameter NC Removal
- `DMR_MSG_NC_REM` - Diameter NC Removal
- `DMR_MSG_TIMER_CFG` - Diameter Timer Configuration

### 4.3.1 Configuration Parameter Format

All configuration messages for DMR use a Name-Length-Data structure within the parameter area to allow for variable size parameters and extensibility.

The Name-Length-Data method is used by several other Dialogic® DSI Stack Layers but the scheme used for DMR is different in that it always uses two bytes for the Parameter Name, two bytes for the Parameter Length and two bytes for the terminator zero. It recommended that the rpackbytes() Development Package function is used for this.

The parameter area for each configuration message is constructed as a list of parameters (each in Name-Length-Data format), followed by a two byte terminator Name (set to zero) indicating that there are no further parameters.

For each message the first configuration parameter contains the main fixed length configuration parameters for the message.

The following diagrams illustrate the parameter area coding:

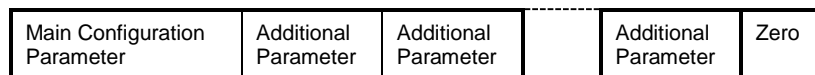

Each parameter is formatted as follows:

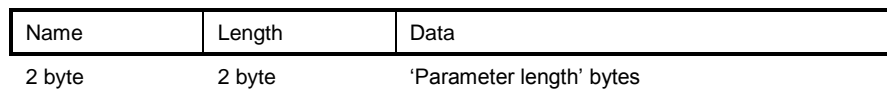

### 4.3.2 Configuration Parameter Definitions

Parameter	Mnemonic	Value (decimal)	Value (hex)	Type
Module Configuration	DMRCN_MOD_CONFIG	1	0x01	Compound parameter See section 4.3.3
Network context	DMRCN_NC_CFG	2	0x02	Compound parameter See section 4.3.4
Peer Configuration	DMRCN_PEER_CFG	3	0x03	Compound parameter See section 4.3.6
Application Configuration	DMRCN_APP_CFG	4	0x04	Compound parameter See section 4.3.7
Route Configuration	DMRCN_ROUTE_CFG	5	0x05	Compound parameter See section 4.3.7
Route List Configuration	DMRCN_ROUTE_LIST_CFG	6	0x06	Compound parameter See section 4.3.8
Origination Host	DMRCN_ORIGIN_HOST	7	0x07	String
Origination Realm	DMRCN_ORIGIN_REALM	8	0x08	String
Node Name	DMRCN_NODE_NAME	9	0x09	String
Peer Host	DMRCN_PEER_HOST	10	0x0a	String
Peer Realm	DMRCN_PEER_REALM	11	0x0b	String
Destination Host	DMRCN_DEST_HOST	12	0x0c	String
Destination Realm	DMRCN_DEST_REALM	13	0x0d	String
Event Information	DMRCN_EVENT_INFO	14	0x0e	Compound parameter See section 4.5.1
Error Information	DMRCN_ERROR_INFO	15	0x0f	Compound parameter See section 4.5.2
Array of app ids	DMRCN_APP_IDS	16	0x10	Compound parameter See section 4.5.3
IP Address	DMRCN_IP_ADDR	17	0x11	See section 4.3.6
Policy Id	DMRCN_POLICY_ID	18	0x12	See section 4.3.7
Diameter Application Id	DMRCN_DMTR_APP_ID	19	0x13	See section 4.3.7
Timer (Session Guard)	DMRCN_TGUARD	20	0x14	Unsigned 32 bit value in ms.
Timer (Transaction Reply)	DMRCN_TREPLY	21	0x15	Unsigned 32 bit value in ms.
Timer (Peer State)	DMRCN_TPSTATE	22	0x16	Unsigned 32 bit value in ms.
Timer (Peer Watchdog)	DMRCN_TPWDOG	23	0x17	Unsigned 32 bit value ms.
Timer (Peer Disconnect)	DMRCN_TPDISCONNECT	24	0x18	Unsigned 32 bit value in ms.
Timer (Peer Reconnect)	DMRCN_TPRECONNECT	25	0x19	Unsigned 32 bit value in ms.
Timer (Tcc)	DMRCN_TTCC	26	0x1a	Unsigned 32 bit value ms.

### 4.3.3 DMR\_MSG\_CONFIG - Diameter Configuration Message

#### Synopsis

Message used to configure the Diameter module (DMR) for operation.

#### Format

Message Header		
Field Name	Meaning	
type	DMR_MSG_CONFIG (0x7460)	
id	0	
src	Management Module Id	
dst	DMR_TASK_ID	
rsp_req	0	
hclass	0	
status	0	
err_info	0	
len	variable	
Parameter Area		
Offset	Size	Name
0	Len -2	Parameters in Name-Length-Data format.
Len -2	2	Set to zero indicating end of message.

#### Description

This message is used to configure DMR for operation. It should be the first message sent to DMR and any messages received before a valid configuration message will be discarded. It should only be issued once.

The message parameters relate to the environment in which DMR is operating and the various capabilities which will be required of the module.

#### Parameters

DMR_MSG_CONFIG (0x7460)			
Parameter	Mandatory/ Optional	Default Value	Notes
DMRCN_MOD_CONFIG	M	n/a	

#### MOD\_CONFIG

DMRCN_MOD_CONFIG parameter		
Offset	Size	Name
0	1	maint_id
1	1	trace_id
2	1	sctp_id

DMRCN_MOD_CONFIG parameter		
Offset	Size	Name
3	1	Reserved (set to zero)
4	2	max_peers
6	4	base_og_id
10	4	base_ic_id
14	4	nog_sessions
18	4	nic_sessions
22	4	max_throughput
26	4	options

**maint\_id**

Maintenance module ID. This is the module to which event and error indications are sent.

**trace\_id**

Trace module ID. This is the module to which any trace messages will be sent.

**sctp\_id**

SCTP module ID. This is the module\_id of the transport layer.

**max\_peers**

The maximum number of Diameter peers that the module is required to support. This value is compared with any internal limits.

**base\_og\_id**

The first session ID for outgoing sessions that the user wishes to be handled by DMR. The subsequent (nog\_sessions - 1) session IDs will also be handled by the module. The user must ensure that the values used in the session ID field of all protocol messages pertaining to outgoing sessions lie within the correct range.

**base\_ic\_id**

The first session ID for incoming sessions that the user wishes to be handled by DMR. The subsequent (nic\_sessions - 1) session IDs will also be handled by the module. The Diameter Module allocates the session ID for each incoming session. It uses values in the range

**nog\_sessions**

The maximum number of simultaneous outgoing sessions that the module is required to support. This value is compared with any internal limits.

**nic\_sessions**

The maximum number of simultaneous incoming sessions that the module is required to support. This value is compared with any internal limits.

**max\_throughput**

This parameter is reserved for future use and should be set to zero.

**options**

Run-time options field, reserved for future use set to zero

### 4.3.4 DMR\_MSG\_NC\_CFG – Diameter NC Configuration

#### Synopsis

Message sent to DMR to configure a Diameter Network Context.

#### Format

Message Header		
Field Name	Meaning	
Type	DMR_MSG_NC_CFG (0x7461)	
Id	nc_id	
Src	Sending module id	
Dst	DMR_TASK_ID	
rsp_req	0	
Hclass	0	
Status	0	
err_info	0	
Len	variable	
Parameter Area		
Offset	Size	Name
0	Len -2	Parameters in Name-Length-Data format.
Len -2	2	Set to zero indicating end of message.

#### Description

The message allows the configuration of independent Diameter Network Contexts. Each Network Context embodies a separate Diameter Node each of which can be independently configured allowing different behaviour and routing rules for the module.

#### Parameters

DMR_MSG_NC_CFG (0x7461)			
Parameter	Mandatory/ Optional	Default Value	Notes
DMRCN_NC_CFG	M		
DMRCN_ORIGIN_HOST	M		
DMRCN_ORIGIN_REALM	M		
DMRCN_NODE_NAME	M		

#### NC\_CFG

DMRCN_NC_CFG parameter		
Offset	Size	Name
0	4	options

**nc\_id**

The logical id for this Network Context for use in communication with local management and maintenance agents.

**node\_name**

The user\_name value which should be used for Diameter protocol messages originated from this node. Formatted as a UTF-8 String.

**origin\_host**

The origin\_host value which should be used for Diameter protocol messages originated from this node. Formatted as a UTF-8 String.

**origin\_realm**

The origin\_realm value which should be used for Diameter protocol messages originated from this node. Formatted as a UTF-8 String.

**options**

Run-time options for this NC assigned according to the following table:

Bit	Mnemonic	Description
0	DMR_NC_OPT_ORIGIN_STATE_ID	Suppress the generation of Origin-State-ID for this network context



### 4.3.5 DMR\_MSG\_APP\_CFG – Diameter Application Configuration

#### Synopsis

Message sent to DMR to configure a Diameter Application for a particular Network Context.

#### Format

Message Header		
Field Name	Meaning	
type	DMR_MSG_APP_CFG (0x7462)	
id	application_id	
src	Sending module_id	
dst	DMR_TASK_ID	
rsp_req	0	
hclass	0	
status	0	
err_info	0	
len	variable	
Parameter Area		
Offset	Size	Name
0	Len -2	Parameters in Name-Length-Data format.
Len -2	2	Set to zero indicating end of message.

#### Description

DMR allows Diameter Applications to be registered against a Network Context. Once configured Peer Connections part of the same Network Context will advertise this Application during Capabilities Exchange and messages received for the application will be forwarded to the configured User module\_id.

#### Parameters

DMR_MSG_APP_CFG (0x7462)			
Parameter	Mandatory/ Optional	Default Value	Notes
DMRCN_APP_CFG	M		

#### APP\_CFG

DMRCN_APP_CFG parameter		
Offset	Size	Name
0	4	options
4	1	mod_id
5	1	reserved (Must be set to 0)

DMRCN_APP_CFG parameter		
Offset	Size	Name
6	2	mod_inst
8	2	nc_id
10	4	vendor_id
14	4	dmtr_app_id

**application ID**

The logical id for the application used in communication with DMR concerning this application. This value is of local significance between DMR and local configuration and maintenance agents. It is distinct and separate to the well-known 'app\_id' value configured later in this message.

**options**

Run-time options for this application. Reserved for future use and should be set to zero.

**mod\_id**

User module ID for this Application.

**mod\_inst**

User Instance for this Application. This is of relevance to DMR-User applications deployed on remote RSI-Hosts.

**nc\_id**

The Network Context Id this application is being registered with.

**vendor\_id**

The Diameter Vendor ID AVP value for use in Diameter capability negotiation.

**dmtr\_app\_id**

The Diameter Application ID AVP value for use in Diameter capability negotiation.

## 4.3.6 DMR\_MSG\_PEER\_CFG – Diameter Peer Configuration

### Synopsis

Message sent to DMR configure a Diameter Peer connection for a particular Network Context.

### Format

Message Header		
Field Name	Meaning	
Type	DMR_MSG_PEER_CFG (0x7463)	
Id	peer_id	
Src	Sending module id	
Dst	DMR_TASK_ID	
rsp_req	0	
Hclass	0	
Status	0	
err_info	0	
Len	variable	
Parameter Area		
Offset	Size	Name
0	Len -2	Parameters in Name-Length-Data format.
Len -2	2	Set to zero indicating end of message.

### Description

The Diameter Module allows Peer Diameter nodes, with which it expects to communicate, to be statically configured. Peer nodes may be Diameter Agents, Servers or Clients and may use dynamically or statically configured transport connections. Each Peer Connection belongs to a pre-configured Network Context.

### Parameters

DMR_MSG_PEER_CFG (0x7463)			
Parameter	Mandatory/ Optional	Default Value	Notes
DMRCN_PEER_CFG	M		
DMRCN_PEER_HOST	M		
DMRCN_PEER_REALM	M		
DMRCN_IP_ADDR	M		

### PEER\_CFG

DMRCN_PEER_CFG parameter		
Offset	Size	Name
0	4	options

DMRCN_PEER_CFG parameter		
Offset	Size	Name
4	2	nc_id
6	2	asc_id

**peer\_id**

The logical id of this Peer used for control and communication of the Peer by local management and maintenance agents.

**options**

Run-time options for this Peer assigned according to the following table:

Bit	Mnemonic	Description
0	DMR_PEER_OPT_SERVER	Set if the transport connection end point acts as the Server side

**nc\_id**

The logical id of a preconfigured Network Context to which this Peer belongs.

**asc\_id**

The logical id of the transport connection used to communicate with this Peer. Messages sent to and received from the Transport Module (e.g. the SCTPN module) must be configured to use this logical id.

**host**

An ASCII or UTF-8 String identifying the expected host-name AVP value for this Peer. This can be used to correlate dynamically created transport connections with pre-configured Peers or to validate statically configured transport addresses advertise the expected host-name AVP value.

**realm**

An ASCII or UTF-8 String identifying the expected realm-name AVP value for this Peer. This can be used to correlate dynamically created transport connections with pre-configured Peers or to validate statically configured transport addresses advertise the expected realm-name AVP value.

**ip\_addr**

The local IP addresses to be advertised to the Peer as part of the capabilities exchange. Allows up to 4 IP addresses, each 17 octets in length formatted as follows:

Octet	Field	Description
0	Format	Set to value 1 indicating an Ipv4 address.
1 .. 4	Network address	Octet 1 containing the most significant byte and octet 4 containing the least significant byte
5 .. 17	Reserved	Should be set to zero.

### 4.3.7 DMR\_MSG\_ROUTE\_CFG – Diameter Route Configuration

#### Synopsis

Message sent to DMR to configure an entry in the Diameter Routing Table for a particular Network Context.

#### Format

Message Header		
Field Name	Meaning	
Type	DMR_MSG_ROUTE_CFG (0x7464)	
Id	route_id	
Src	Sending module id	
Dst	DMR_TASK_ID	
rsp_req	0	
Hclass	0	
Status	0	
err_info	0	
Len	Variable	
Parameter Area		
Offset	Size	Name
0	Len -2	Parameters in Name-Length-Data format.
Len -2	2	Set to zero indicating end of message.

#### Description

The Diameter Routing table allows the configuration of routing rules for use with Diameter Messages received from the User Application.

Selection of a Diameter Peer for message routing is based on network conditions and the following:

- 1) Peer route – Route selection is made based on a match of the Destination-Host protocol parameter
- 2) Realm route – Route selection is made based on a routing key match. The routing key consists of the Destination-Realm and Application-ID protocol parameters; the key also includes the user defined network context and routing policy key
- 3) Default route – User defined default route (per network context)

The message must contain either the DMRRT\_OPT\_DEFAULT run-time option or one of the optional parameters, DMRCN\_DEST\_HOST or DMRCN\_DEST\_REALM.

If the DMRCN\_DEST\_REALM parameter is present, DMRCN\_DMTR\_APP\_ID and DMRCN\_POLICY\_ID may be used.

#### Parameters

DMR_MSG_ROUTE_CFG (0x7464)
----------------------------

Parameter	Mandatory/ Optional	Default Value	Notes
DMRCN_ROUTE_CFG	M		
DMRCN_DEST_HOST	O		Peer based routing (Diameter Destination Host)
DMRCN_DEST_REALM	O		Realm based routing (Diameter Destination Realm)
DMRCN_DMTR_APP_ID	O		Realm based routing (Diameter Application- Id)
DMRCN_POLICY_ID	O		Realm based routing (User defined)

### ROUTE\_CFG

DMRCN_ROUTE_CFG parameter		
Offset	Size	Name
0	4	options
4	2	nc_id

### options

Run-time options for this Peer assigned according to the following table:

Bit	Mnemonic	Description
0	DMRRT_OPT_DEFAULT	Designates this route as the Default Route for this Network Context. A default route will be used if an attempt to route does not match a host-based or realm-based route.
1	DMRRT_OPT_LOAD_SHARE	Load share traffic between available peer connections based on NAI value.

### nc\_id

The logical id of the Network Context for which this route applies.

### DMRCN\_DMTR\_APP\_ID

The Diameter Application Identifier for which this route applies.

DMRCN_DMTR_APP_ID parameter		
Offset	Size	Name
0	4	dmtr_app_id

### DMRCN\_POLICY\_ID

A user defined identifier providing a routing policy for the route. The policy id is used to distinguish routes which otherwise share common routing parameters. The value can be used in to control route selection on a per-message basis.

DMRCN_POLICY_ID parameter		
Offset	Size	Name
0	2	dmtr_app_id

### 4.3.8 DMR\_MSG\_ROUTE\_LIST\_CFG – Diameter Route List Configuration

#### Synopsis

Message sent to DMR to configure a single route list entry. Each route list entry defines a mapping between a route and a peer for use in the Diameter Routing Table.

#### Format

Message Header		
Field Name	Meaning	
Type	DMR_MSG_ROUTE_LIST_CFG (0x746f)	
Id	route_list_id	
Src	Sending module id	
Dst	DMR_TASK_ID	
rsp_req	0	
Hclass	0	
Status	0	
err_info	0	
Len	Variable	
Parameter Area		
Offset	Size	Name
0	Len -2	Parameters in Name-Length-Data format.
Len -2	2	Set to zero indicating end of message.

#### Description

The Diameter Routing Table allows static configuration of Route Lists which associate a peer with a route. The peer defined in the Route List is a candidate next hop destination for the route.

A route may be associated with multiple peers and a peer may be associated with multiple routes.

#### Parameters

DMR_MSG_ROUTE_LIST_CFG (0x746f)			
Parameter	Mandatory/ Optional	Default Value	Notes
DMRCN_ROUTE_LIST_CFG	M		

#### ROUTE\_CFG

DMRCN_ROUTE_LIST_CFG parameter		
Offset	Size	Name
0	4	options
4	2	route_id

DMRCN_ROUTE_LIST_CFG parameter		
Offset	Size	Name
6	2	peer_id
8	2	Priority

**options**

Run-time options. Reserved for future use and should be set to zero.

**Route\_id**

The logical id of the route for which the peer\_id will be associated

**peer\_id**

The logical id of the peer which can be used as a next hop destination for the route\_id.

**priority**

The priority of the route\_list within the route. '0' being the highest priority



### 4.3.9 DMR\_MSG\_APP\_REM – Remove Diameter Application Configuration

#### Synopsis

Message sent to DMR to remove a Diameter Application for a particular Network Context.

#### Format

Message Header	
Field Name	Meaning
type	DMR_MSG_APP_REM (0x7477)
id	application_id
src	Sending module_id
dst	DMR_TASK_ID
rsp_req	0
hclass	0
status	0
err_info	0
len	0

#### Description

DMR allows Diameter Applications to be removed from a Network Context. Once removed, Peer Connections part of the same Network Context will no longer advertise this Application during Capabilities Exchange and messages received for the application will be no longer be forwarded to the user.

All peers within the network context must be deactivated prior to removing an application.

All routes within the network context which define a Diameter Application Id as part of its configuration must be removed before attempting to remove an application which shares the same Diameter Application Id.

### 4.3.10 DMR\_MSG\_PEER\_REM – Remove Diameter Peer Configuration

#### Synopsis

Message sent to DMR to remove a Diameter Peer connection for a particular Network Context.

#### Format

Message Header	
Field Name	Meaning
type	DMR_MSG_PEER_REM (0x7478)
id	peer_id
src	Sending module id
dst	DMR_TASK_ID
rsp_req	0
hclass	0
status	0
err_info	0
len	0

#### Description

The Diameter Module allows Peer Diameter nodes, with which it expects to communicate, to be statically configured and removed. Peer nodes may be Diameter Agents, Servers or Clients and may use dynamically or statically configured transport connections. Each Peer Connection belongs to a pre-configured Network Context.

All route list entries which reference a peer must be removed prior to removing the peer configuration.

### 4.3.11 DMR\_MSG\_ROUTE\_REM – Remove a Diameter Route Configuration

#### Synopsis

Message sent to DMR to remove an entry in the Diameter Routing Table for a particular Network Context.

#### Format

Message Header	
Field Name	Meaning
type	DMR_MSG_ROUTE_REM (0x7479)
id	route_id
src	Sending module id
dst	DMR_TASK_ID
rsp_req	0
hclass	0
status	0
err_info	0
len	0

#### Description

The Diameter Routing table may be updated by issuing this message to remove a routing entry. Once removed, user messages will no longer be matched to this route. The next available route matching the routing parameters of the user message will be selected.

All route list entries which reference a route must be removed prior to removing the route configuration.

### 4.3.12 DMR\_MSG\_ROUTE\_LIST\_REM – Remove a Diameter Route List Configuration

#### Synopsis

Message sent to DMR to remove a single route list entry. Each route list entry defines a mapping between a route and a peer for use in the Diameter Routing Table.

#### Format

Message Header	
Field Name	Meaning
type	DMR_MSG_ROUTE_LIST_REM (0x747a)
id	route_list_id
src	Sending module id
dst	DMR_TASK_ID
rsp_req	0
hclass	0
sStatus	0
err_info	0
len	0

#### Description

The Diameter Routing Table allows removal of Route List entries which associate a peer with a route. The peer defined in the Route List is a candidate next hop destination for the route.

### 4.3.13 DMR\_MSG\_NC\_REM – Remove Diameter Network Context Configuration

#### Synopsis

Message sent to DMR to remove a Diameter Network Context configuration.

#### Format

Message Header	
Field Name	Meaning
type	DMR_MSG_APP_REM (0x747b)
id	nc_id
src	Sending module_id
dst	DMR_TASK_ID
rsp_req	0
hclass	0
status	0
err_info	0
len	0

#### Description

DMR allows Diameter Network Contexts to be removed. All resources currently configured within this network context such as Peers, Routes, Route Lists and Applications must be removed prior to removing the Network Context configuration.

### 4.3.14 DMR\_MSG\_TIMER\_CFG – Diameter Timer Configuration

#### Synopsis

Message sent to DMR to configure Diameter Timers.

#### Format

Message Header		
Field Name	Meaning	
type	DMR_MSG_TIMER_CFG (0x747c)	
id	0	
src	Sending module_id	
dst	DMR_TASK_ID	
rsp_req	0	
hclass	0	
status	0	
err_info	0	
len	0	
Parameter Area		
Offset	Size	Name
0	Len -2	Parameters in Name-Length-Data format.
Len -2	2	Set to zero indicating end of message.

#### Description

This message allows the user to configure timer values.

#### Parameters

Note all timer values are submitted in ms.

DMR_MSG_TIMER_CFG (0x747c)			
Parameter	Mandatory/ Optional	Default Value	Notes
DMRCN_TGUARD	O	5,000ms	Waiting for User application to respond
DMRCN_TREPLY	O	5,000ms	Waiting for network response.
DMRCN_TPSTATE	O	5,000ms	Waiting for response from peer.
DMRCN_TPWDG	O	30,000ms	Delay between peer watchdog requests
DMRCN_TPDISCONNECT	O	1000ms	
DMRCN_TPRECONNECT	O	5,000ms	
DMRCN_TTCC	O	120,000ms	CC/Ro Server side session timeout (RFC4006)

## 4.4 Management Request Messages

This section details the format of the following management request messages that can be used to interface with DMR for control purposes or to request status.

- DMR\_MSG\_PEER\_ACTIVATE – Diameter Peer Activate Request
- DMR\_MSG\_PEER\_DEACTIVATE – Diameter Peer Deactivate Request
- DMR\_MSG\_S\_TRACE\_MASK – Set Diameter Trace Masks
- DMR\_MSG\_R\_NC\_STATS – Diameter NC Statistics
- DMR\_MSG\_R\_PEER\_STATE – Read Peer State Request
- DMR\_MSG\_R\_PEER\_STATS – Diameter Peer Statistics
- DMR\_MSG\_R\_APP\_STATS – Diameter Application Statistics
- DMR\_MSG\_R\_ROUTE\_STATS – Diameter Route Statistics
- DMR\_MSG\_R\_RL\_STATS – Diameter Route List Statistics

### 4.4.1 DMR\_MSG\_PEER\_ACTIVATE – Diameter Peer Activate Request

#### Synopsis

This primitive is used by management to request DMR to activate the connection to the identified peer.

#### Format

Message Header	
Field Name	Meaning
type	DMR_MSG_PEER_ACTIVATE (0x7469)
id	peer_id
src	Sending module id
dst	DMR_TASK_ID
rsp_req	0
hclass	0
status	0
err_info	0
len	0

#### Description

On receipt of this message, DMR attempts to activate the specified Peer connection. Receipt of a confirmation message does not imply the connection is available for use merely that DMR is attempting to bring the connection into service. Peer availability is indicated through the DMR\_MSG\_PEER\_STATE\_IND message.

The user can determine the current state of a Peer connection on demand using the DMR\_MSG\_R\_PEER\_STATUS message.



## 4.4.2 DMR\_MSG\_PEER\_DEACTIVATE – Diameter Peer Deactivate Request

### Synopsis

This primitive is used by management to request DMR to deactivate the specified peer connection.

### Format

Message Header	
Field Name	Meaning
type	DMR_MSG_PEER_DEACTIVATE (0x746a)
id	peer_id
src	Sending module id
dst	DMR_TASK_ID
rsp_req	0
hclass	0
status	0
err_info	0
len	0

### Description

On receipt of this message DMR attempts to deactivate the specified Peer connection

### 4.4.3 DMR\_MSG\_S\_TRACE\_MASK – Set Diameter Trace Masks

#### Synopsis

Message used by management to set the DMR trace masks.

#### Format

Message Header		
Field Name		Meaning
type		DMR_MSG_S_TRACE_MASK (0x6467)
id		0
src		Sending module id
dst		DMR_TASK_ID
rsp_req		0
hclass		0
status		0
err_info		0
len		12
Parameter Area		
Offset	Size	Name
0	4	op_mask
4	4	ip_mask
8	4	mngt_mask

#### Description

The trace masks allow the user to request messages generated and received by the DMR module to be copied and traced to the trace module for diagnostic purposes. Tracing can be turned on and off dynamically on a per primitive basis. Tracing is controlled by three 32 bit masks (output, input and management) and bits set to one in the mask cause messages of that type to be traced.

#### Parameters

##### op\_mask

The output event trace mask. This is a 32-bit value with bits set to 1 to cause a trace message to be sent to the trace module when DMR sends the associated protocol message.

Bit	Message to be Traced	Description
0	DMR_MSG_SESSION_IND	Trace session indication primitives issued to user by DMR.
1	DMR_MSG_EVENT_IND	Trace event indication issued by DMR.
2	DMR_MSG_ERROR_IND	Trace error indications issued by DMR.
3	SCTP_MSG_ACTIVATE	Trace SCTP activation requests issued by DMR.
4	SCTP_MSG_SHUTDOWN	Trace SCTP shutdown requests issued by DMR.
5	SCTP_MSG_TX_REQ	Trace SCTP transmit requests issued by DMR.
7 to 31		Reserved for future use and should be set to zero.

**Ip\_mask**

The input event trace mask. This is a 32-bit value with bits set to 1 to cause a trace message to be sent to the system trace module when DMR receives the associated protocol message.

Bit	Message to be Traced	Description
0	DMR_MSG_SESSION_REQ	Trace session request primitives received by DMR.
1	SCTP_MSG_RX_IND	Trace SCTP receive indications received by DMR.
2	SCTP_MSG_STATUS_CHANGE	Trace SCTP status messages received by DMR.
3	SCTP_MSG_CONG_STATUS	Trace SCTP congestion indications received by DMR.
4 to 31		Reserved for future use and should be set to zero.

**mngt\_mask**

The management event trace mask. This is a 32-bit value with bits set to 1 to cause a trace message to be sent to the system trace module when DMR receives the associated protocol message.

Bit	Message to be Traced	Description
0	DMR_MSG_S_TRACE_MASK	Trace any set trace mask primitives received by DMR.
1	DMR_MSG_NC_CFG	Trace NC configuration messages received by DMR.
2	DMR_MSG_PEER_CFG	Trace peer configuration messages received by DMR.
3	DMR_MSG_PEER_ACTIVATE	Trace peer activation requests received by DMR.
4	DMR_MSG_PEER_DEACTIVATE	Trace peer deactivation requests received by DMR.
5		Reserved for future use. Set to zero.
6	DMR_MSG_APP_CFG	Trace application configuration messages received by DMR.
7	DMR_MSG_ROUTE_CFG	Trace route configuration messages received by DMR.
8	DMR_MSG_R_NC_STATS	Trace read NC stats requests received by DMR.
9	DMR_MSG_R_PEER_STATE	Trace read peer state requests received by DMR.
10		Reserved for future use. Set to zero.
11	DMR_MSG_ROUTE_LIST_CFG	Trace route list configuration messages received by DMR.
12 to 31		Reserved for future use and should be set to zero.

#### 4.4.4 DMR\_MSG\_R\_NC\_STATS – Diameter NC Statistics

##### Synopsis

Message used to query measurements for a specific Diameter Network Context.

##### Format

Message Header		
Field Name	Meaning	
type	DMR_MSG_R_NC_STATS (0x646e)	
id	nc_id	
src	Sending module id	
dst	DMR_TASK_ID	
rsp_req	Sending layer’s bit must be set	
hclass	0	
status	0 – Leave stats unchanged 1 – Reset stats after reading	
err_info	0	
len	20	
Parameter Area		
Offset	Size	Name
0	4	ssn_alloc_count
4	4	ssn_dealloc_count
8	4	tran_alloc_count
12	4	tran_dealloc_count
16	4	ssn_discard_count

##### Description

This message allows the user to query the Network Context to determine its current usage of system resources. The counters can be reset or left unchanged depending on the setting of the status field. The user should send the message with all fields set to zero.

**Note:** In this context a transaction is made up of a Diameter Request and a corresponding Diameter Answer. A session is made up of one or more transactions between two peer entities.

##### Parameters

###### ssn\_alloc\_count

The number of session resources which have been allocated.

###### Ssn\_dealloc\_count

The number of session resources which have been de-allocated.

###### Tran\_alloc\_count

The number of transaction resources which have been allocated.

**Tran\_dealloc\_count**

The number of transaction resources which have been de-allocated.

**Ssn\_discard\_count**

The number of new sessions discarded by dmr due to throughput enforcement

## 4.4.5 DMR\_MSG\_R\_PEER\_STATE – Read Peer State Request

### Synopsis

Message used to query the current Peer State.

### Format

Message Header		
Field Name	Meaning	
type	DMR_MSG_R_PEER_STATE (0x6470)	
id	peer_id	
src	Sending module id	
dst	DMR_TASK_ID	
rsp_req	Sending layer’s bit must be set	
hclass	0	
status	0	
err_info	0	
len	3	
Parameter Area		
Offset	Size	Name
0	1	availability
1	2	State_flags

### Description

This message allows the user to query the Peer State. The user should allocate a message with sufficient space in the parameter area and DMR will fill in the parameter area in the response message.

### Parameters

#### availability

Peer availability state. Possible values are shown in the table below:

Value	Mnemonic	Description
0	DMR_PEER_STATE_UNKNOWN	Entered Unknown State
1	DMR_PEER_STATE_CLOSED	Entered CLOSED State
2	DMR_PEER_STATE_OPEN	Entered OPEN State

#### state\_flags

Additional state information related to the peer. Bit 0 is set to 1 if a request to activate the peer has been made. All other bits are reserved for future use and will be set to zero.

## 4.4.6 DMR\_MSG\_R\_PEER\_STATS – Diameter Peer Statistics

### Synopsis

Message used to query measurements for a specific Diameter Peer.

### Format

Message Header		
Field Name	Meaning	
type	DMR_MSG_R_PEER_STATS (0x6473)	
id	peer_id	
src	Sending module id	
dst	DMR_TASK_ID	
rsp_req	Sending layer's bit must be set	
hclass	0	
status	0 – Leave stats unchanged 1 – Reset stats after reading	
err_info	0	
len	32	
Parameter Area		
Offset	Size	Name
0	4	Period
4	4	tx_octet
8	4	rx_octet
12	4	tx_msg
16	4	rx_msg
20	4	peer_error
24	4	closed_cnt
28	4	open_duration

### Description

This message allows the user to query a specific peer to read measurements. The counters can be reset or left unchanged depending on the setting of the status field. The user should send the message with all fields set to zero.

### Parameters

#### period

Period over which the measurements have been collected (in multiples of 100ms).

#### Tx\_octet

Number of octets transmitted.

#### Rx\_octet

Number of octets received.



**Tx\_msg**

Number of messages transmitted.

**Rx\_msg**

Number of messages received.

**Peer\_error**

Number of errors associated with this peer including peer timeouts, unexpected messages and remote disconnections.

**Closed\_cnt**

Count of state transitions to the CLOSED state.

**Open\_duration**

Duration within period the Peer has been in the OPEN state (in multiples of 100ms).

## 4.4.7 DMR\_MSG\_R\_APP\_STATS – Diameter Application Statistics

### Synopsis

Message used to query measurements for a specific Diameter Application.

### Format

Message Header		
Field Name	Meaning	
type	DMR_MSG_R_APP_STATS (0x6474)	
id	application_id	
src	Sending module id	
dst	DMR_TASK_ID	
rsp_req	Sending layer's bit must be set	
hclass	0	
status	0 – Leave stats unchanged 1 – Reset stats after reading	
err_info	0	
len	20	
Parameter Area		
Offset	Size	Name
0	4	period
4	4	tx_octet
8	4	rx_octet
12	4	tx_msg
16	4	rx_msg

### Description

This message allows the user to query a specific application to read measurements. The counters can be reset or left unchanged depending on the setting of the status field. The user should send the message with all fields set to zero.

### Parameters

#### period

Period over which the measurements have been collected (in multiples of 100ms).

#### Tx\_octet

Number of octets transmitted.

#### Rx\_octet

Number of octets received.

#### Tx\_msg

Number of messages transmitted.

**Rx\_msg**

Number of messages received.

## 4.4.8 DMR\_MSG\_R\_ROUTE\_STATS – Diameter Route Statistics

### Synopsis

Message used to query measurements for a specific Diameter Route.

### Format

Message Header		
Field Name	Meaning	
type	DMR_MSG_R_ROUTE_STATS (0x6475)	
id	route_id	
src	Sending module id	
dst	DMR_TASK_ID	
rsp_req	Sending layer's bit must be set	
hclass	0	
status	0 – Leave stats unchanged 1 – Reset stats after reading	
err_info	0	
len	16	
Parameter Area		
Offset	Size	Name
0	4	period
4	4	tx_octet
8	4	tx_msg
12	4	redirect

### Description

This message allows the user to query a specific Diameter route to read measurements. The counters can be reset or left unchanged depending on the setting of the status field. The user should send the message with all fields set to zero.

### Parameters

#### period

Period over which the measurements have been collected (in multiples of 100ms).

#### Tx\_octet

Number of user provided octets transmitted over this route.

#### Tx\_msg

Number of user provided messages transmitted over this route.

#### Redirect

Number of Diameter messages redirected to an alternative peer.

## 4.4.9 DMR\_MSG\_R\_RL\_STATS – Diameter Route List Statistics

### Synopsis

Message used to query measurements for a specific Diameter Route List entry.

### Format

Message Header		
Field Name	Meaning	
type	DMR_MSG_R_RL_STATS (0x6476)	
id	route_list_id	
src	Sending module id	
dst	DMR_TASK_ID	
rsp_req	Sending layer's bit must be set	
hclass	0	
status	0 – Leave stats unchanged 1 – Reset stats after reading	
err_info	0	
len	12	
Parameter Area		
Offset	Size	Name
0	4	period
4	4	down_count
8	4	up_duration

### Description

This message allows the user to query a specific Diameter Route List entry to read measurements. The counters can be reset or left unchanged depending on the setting of the status field. The user should send the message with all fields set to zero.

### Parameters

#### period

Period over which the measurements have been collected (in multiples of 100ms).

#### Down\_count

Count of Route List state transitions to the DOWN state.

#### Up\_duration

Duration within period the Route List has been in the UP state (in multiples of 100ms).

## 4.5 Event Indication Messages

Event indication messages are the mechanism by which protocol and software error events are reported to management.

The following event indication messages generated by DMR are documented in this section:

- DMR\_MSG\_EVENT\_IND - Diameter Event Indication
- DMR\_MSG\_ERROR\_IND - Diameter Error Indication
- DMR\_MSG\_PEER\_STATE\_IND - Peer Connection State Indication

## 4.5.1 DMR\_MSG\_EVENT\_IND – Diameter Event Indication

### Synopsis

Message sent by DMR to the management module to indicate a protocol related event has occurred.

### Format

Message Header		
Field Name	Meaning	
type	DMR_MSG_EVENT_IND (0x0465)	
id	See below	
src	DMR_TASK_ID	
dst	Maintenance module id	
rsp_req	0	
hclass	0	
status	Event Code (see below)	
err_info	0	
len	8	
Parameter Area		
Offset	Size	Name
0	4	param1
4	4	param2

### Description

Message used by DMR to indicate a Diameter protocol event has occurred.

### Parameters

#### Event Code

The event code contained in the status field of the message indicates the type of event. Possible values are listed in the following table that also lists the meaning of the id field, param1 and param2 in each case. Unused values are set to zero.

Code	Mnemonic	Id	Param1	Param2	Description
1	DMR_EVENT_DECODE_AVP_MISSING	0	int_status		A mandatory AVP is missing from a diameter message.
2	DMR_EVENT_DECODE_AVP_DOESNT_BELOW	int_status	0	0	An inappropriate AVP has been detected whilst decoding
3	DMR_EVENT_DECODE_AVP_MISFORMATED	nc_id	AVP id	len	An AVP has been decode with an invalid format, e.g. Bad length

Code	Mnemonic	Id	Param1	Param2	Description
4	DMR_EVENT_DECODE_AVP_ERROR	nc_id	AVP code	bytes_processed	A badly formatted Diameter Message has been received. Param2 indicates the offset of the error within the Diameter message
5	DMR_EVENT_DECODE_MSG_ERROR	session_id	0	0	Decoding of message detected a problem
6	DMR_EVENT_DECODE_PEER_NAME	peer_id	0	0	Could not decode Peer name as part of Capability Exchange.
7	DMR_EVENT_DECODE_PEER_REALM	peer_id	0	0	Could not decode Peer realm as part of Capability Exchange.
10	DMR_EVENT_NC_UNKNOWN	0	nc_id		The identified network context ID is invalid.
11	DMR_EVENT_NC_UNKNOWN_APP_ID	nc_id	app_id	0	Could not identify application based on an unknown application id.
12	DMR_EVENT_NC_APP_ID	0	0	0	
20	DMR_EVENT_PEER_ERROR	peer_id	num_app	0	An error adding an application to a peer has occurred.
21	DMR_EVENT_PEER_REFUSED	peer_id	0	0	A dynamic connection request has been refused
22	DMR_EVENT_PEER_UNEX_REALM	peer_id	0	0	The peers advertised realm name does not match that configured.
23	DMR_EVENT_PEER_UNEX_HOST	peer_id	0	0	The peers advertised host name does not match that configured.
24	DMR_EVENT_PEER_UNEX_ASC_ID	assoc_id	0	0	Unexpected association for peer
25	DMR_EVENT_PEER_CAP_EX_NO_COMMON_APPS	peer_id	0	0	A capability exchange procedure failed due to no common applications
26	DMR_EVENT_PEER_CAP_EX_NO_COMMON_SECURITY	peer_id	0	0	A capability exchange procedure failed due to no common security



Code	Mnemonic	Id	Param1	Param2	Description
27	DMR_ERROR_PEER_C AP_EX_FAILED	peer_id	0	0	A capability exchange procedure failed
28	DMR_EVENT_PEER_D PR_RXED	peer_id	Disconnecti on-cause AVP value	0	A DPR message has been received
29	DMR_EVENT_PEER_U NEX_APP_ID	peer_id	Application- Id	0	An unexpected Application-Id has been received.
30	DMR_EVENT_TRAN_R UN_OUT	0	0	0	The system failed to allocate a new transaction resource
40	DMR_EVENT_SSN_BA D_ID	session_id	0	0	An event has been received for a session id which is not in use
41	DMR_EVENT_SSN_INV ALID_ID	session_id	0	0	An event has been received for a session id which is invalid
42	DMR_EVENT_SSN_RU N_OUT	0	0	0	The module has run out of session resources to allocate
51	DMR_EVENT_REQ_BA D_PRIM_TYPE	session_id	0	0	User request contained an unknown primitive type.
52	DMR_EVENT_REQ_MI SSING_PARAM		param tag	primitive type	A mandatory parameter is missing from the request
53	DMR_EVENT_REQ_DM TR_REQ_FLAG	session_id	0	0	The Diameter request flag is set - reset expected
54	DMR_EVENT_REQ_BA D_DMTR_MSG	session_id	nc_id	0	A problem was found parsing with the request values
55	DMR_EVENT_REQ_ BAD_APP_ID	0	nc_id	application_id	Session request received for an unknown and unhandled application
56	DMR_EVENT_REQ_ TOO_SHORT	session_id	len	0	The DMR_SESSION_RE Q message was too short
57	DMR_EVENT_REQ_ BAD_PARAM	session_id	param_tag	len	A problem was found parsing the request format
58	DMR_EVENT_REQ_ BAD_FMT	session_id	0	0	The parameter was an invalid length

Code	Mnemonic	Id	Param1	Param2	Description
59	DMR_EVENT_REQ_BAD_TERM	session_id	0	0	The terminating two bytes should have value zero.
60	DMR_EVENT_REQ_UNEX_PRIM	session_id	0	0	Unexpected primitive type received for the session in use.
61	DMR_EVENT_REQ_NO_DEST_AVP	session_id	0	0	Request has no host or realm specified
62	DMR_EVENT_REQ_NO_RESULT_AVP	session_id	0	0	Request has no result or experimental result code specified
63	DMR_EVENT_REQ_MISSING_AVP	session_id	0	0	A required AVP for message is missing
70	DMR_EVENT_ROUTE_UNKNOWN	session_id	nc_id	0	An appropriate route could not be selected
71	DMR_EVENT_ROUTE_UNAVAILABLE	rte_id	session_id	0	The Route selected is currently unavailable for routing.

## 4.5.2 DMR\_MSG\_ERROR\_IND – Diameter Error Indication

### Synopsis

Message sent by DMR to the management module to indicate an exceptional or erroneous protocol event or implementation error has occurred.

### Format

Message Header		
Field Name	Meaning	
type	DMR_MSG_ERROR_IND (0x0466)	
id	See below	
src	DMR_TASK_ID	
dst	Maintenance module id	
rsp_req	0	
hclass	0	
status	error_code (see below)	
err_info	0	
len	8	
Parameter Area		
Offset	Size	Name
0	4	param1
4	4	param2

### Description

This message used by DMR to convey the occurrence of an exceptional or erroneous protocol event or implementation error and to convey additional diagnostic information to facilitate investigation of the problem.

### Parameters

#### error\_code

The error code contained in the status field of the message indicates the type of error. Possible values are listed in the following table that also lists the meaning of the id field, param1 and param2 in each case. Unused values are set to zero.

Code	Mnemonic	Id	param1	param2	Description
1	DMR_ERROR_PEER_CREATION_FAILED	peer_id	int_status	0	Creation of a Peer could not be performed
2	DMR_ERROR_PEER_UNKNWN_ERROR,	peer_id	0	0	An event occurred for an unknown peer
3	DMR_ERROR_PEER_NOT_IN_USE	peer_id	0	0	An event unexpectedly occurred for a peer not in use
10	DMR_ERROR_SSN_OOB_EVENT	session_id	0	0	An event has occurred for a session id that is not in use or out of bounds
11	DMR_ERROR_SSN_CREATION_FAILED	session_id	int_status	0	A session could not be created
12	DMR_ERROR_SSN_ANS_TX_FAILED	session_id	Int_status	0	An attempt to send Answer message has failed
13	DMR_ERROR_SSN_DESTRUCT_FAILED	session_id	int_status	0	An attempt to close a session failed
14	DMR_ERROR_SSN_UNEX_EVENT	session_id	session_type	0	An event has been received which is unexpected for the session type
20	DMR_ERROR_ROUTE_BAD_PEER_ID	route_id	peer_id	0	Request processing failed due to an inappropriate peer_id
30	DMR_ERROR_UNEXP_EVENT	nc_id	0	app_id	An unexpected event was detected during session processing

### 4.5.3 DMR\_MSG\_PEER\_STATE\_IND - Peer Connection State Indication

#### Synopsis

Message issued by DMR to advise management of changes in state of the Peer connection.

#### Format

Message Header		
Field Name	Meaning	
type	DMR_MSG_PEER_STATE_IND (0x0468)	
id	peer_id	
src	DMR_TASK_ID	
dst	Maintenance module id	
rsp_req	0	
hclass	0	
status	peer_state (see below)	
err_info	0	
len	variable	
Parameter Area		
Offset	Size	Name
0	Len -2	Parameters in Name-Length-Data format.
Len -2	2	Set to zero indicating end of message.

#### Description

This primitive is used by DMR to advise management of changes of state of the Peer Connection. This message is intended for diagnostic and maintenance purposes and does not form part of the protocol specified primitives.

#### Parameters

##### peer\_state

The new state of the Peer connection. The following table shows the possible values and their meanings:

Value	Mnemonic	Description
0	DMR_PEER_STATE_UNKNOWN	Entered Unknown State
1	DMR_PEER_STATE_CLOSED	Entered CLOSED State
2	DMR_PEER_STATE_OPEN	Entered OPEN State

#### APP\_IDS

An array of App Ids which are appropriate for this Indication.

DMRCN_APP_IDS parameter		
Offset	Size	Name
0	2	App id (First in array)
...		
$(N - 1) * 2$	2	App Id ( $N^{\text{th}}$ in array)

## 5 External Message Definitions

The Dialogic® DSI Diameter Stack is intended for use in conjunction with the Dialogic® DSI SIGTRAN Stack SCTP Layer. Specifically, it is intended for use with the SCTPN binary which makes use of the Native SCTP stack within the host operating system. It provides a DSI message based interface which is used by the DSI Diameter Stack for the purpose of controlling the SCTP associations and transferring data to the peer node.

Detail of the interface to the SCTPN binary is contained within the *Dialogic® DSI SCTP Programmer's Manual*.

The following primitives are used by the DSI Diameter Stack:

Primitive	Message Type	Description
SCTP Activate association	0x728a	Used by Diameter to activate an SCTP association.
SCTP Shutdown association	0x728b	Used by Diameter to gracefully close down an SCTP association
SCTP Abort association	0x728c	Used by Diameter to initiate the abort of an SCTP association
SCTP Data transfer request	0xc280	Used by Diameter to transmit a data packet over an association.
SCTP Status change	0x028d	Indication from SCTP of a change in association status.
SCTP Data transfer indication	0x8281	Indication from SCTP of a received data packet.
SCTP Congestion status	0x028f	Indication from SCTP of a change in the congestion status of the association
SCTP Network status	0x028e	Indication from SCTP of a change in status a network address within an association.